



order number : 556

**Connector AM-TOP**

with cable gland

32A4P 6H400V connector AM-TOP IP67

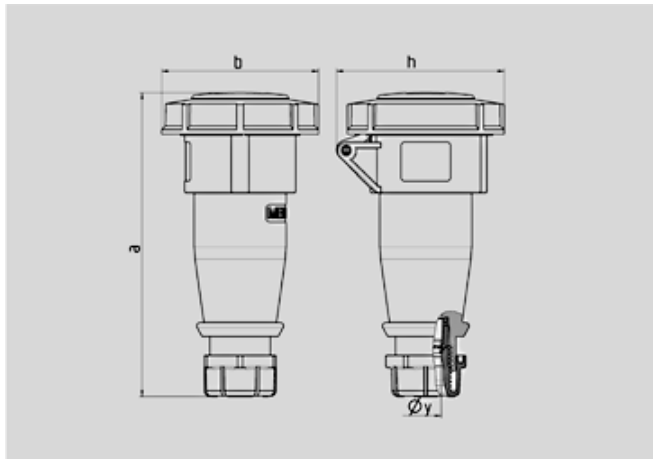

Zeichnung	Amp.	16			32		
		3	4	5	3	4	5
3 MB 62	Pole						
Maße in mm	a	146	166	172	212	212	213
	b	72	79	89	96	96	102
	h	80	88	95	98	98	105
	y	14,5	16	16	22	22	22
Leiterquerschnitt von bis mm <sup>2</sup>		1	1	1	2,5	2,5	2,5
		-2,5	-2,5	-2,5	-6	-6	-6

 Article-group : **3149**

voltages : 400V

rated current : 32A

pole : 4 pole

IP protection types : IP67

position of ground contact : 6h

packing unit : 0010







pilot contact (63A-125A) : without pilot-contact

contact carriers : standard

contact technique : screw contact

weight : 280 g

**PART NUMBERS**

	V	110V	230V	400V	500V	>50-500V	
		50,60	50,60	50,60	50,60	100-300	300-500
	Hz						
	colour						
	amp.						
<b>16 A</b>	3	539	540	541			
	4	542	543	544	545	546	547
	5	548	549	550			
<b>32 A</b>	3	551	552	553			
	4	554	555	<u>556</u>	557	558	559
	5	560	561	562			